

Lightpad

Lightpad is a free-standing luminaire designed to respond to your individual requirements at the workplace. It features a choice of luminaire heads with different luminous intensity distributions to guarantee uniform lighting for a wide range of desk configurations. The luminaire delivers asymmetric

and double asymmetric light distribution, thus meeting the requirements laid down in the standards for the uniform illumination of workstations. Base plates are available in different designs. In short: we think in terms of desks, not in illuminance levels.

FEATURES

Double asymmetric light distribution ensures uniform, shadow-free illumination of the workplace

Ultra-slim housing design of just 19 mm

Up to 4 luminaire heads can be mounted on one stand, minimising the visual impact in the space

ALONEatWORK® communication module

SensoDim® 3 presence detector and daylight sensor in each of the luminaire heads

Designed for connection to Light Hub

Luminous efficacy of up to 119 lm/W

Suitable for office lighting (UGR < 19; $L_{max} \geq 65^\circ \leq 3000 \text{ cd/m}^2$)

Design: schneider+schumacher, Frankfurt am Main

TECHNICAL DATA

System power	57 W – 196 W
Luminous flux of luminaire	6500 lm – 22800 lm
Colour temperature	3000 K / 4000 K
Colour Rendering Index (CRI)	> 80
Life time	L90 50'000 h
Protection class	I
Ingress Protection	IP20

SPECIFICATIONS

Direct-indirect light emission

Height: 2000 mm

Height luminaire head: 19 mm

Colours: white, silver, black

APPLICATION AREAS

Office & Education: open-plan offices, individual offices



IP20 650°C 230V **LED**

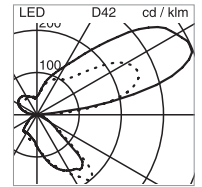
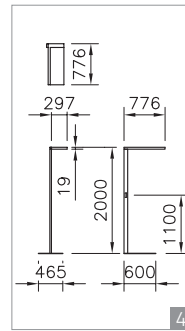
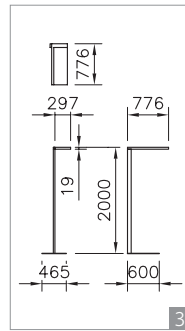
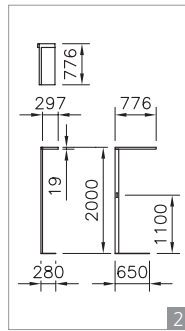
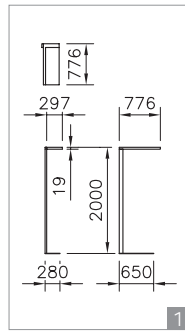

FREESTANDING LUMINAIRE LIGHTPAD LED
FOR SINGLE PERSON WORKSTATION, LEFT

System power	Luminous flux of luminaire	Colour temperature	Colour	Base plate shape	Control element	Ref. n° Plug: CH	Ref. n° Plug: EU
57 W	6500 lm	4000 K	white	Base plate, full mould, oblong	without control element	1 1022.2926	1022.2927
57 W	6200 lm	3000 K	white	Base plate, full mould, oblong	without control element	1 1022.2918	1022.2919
57 W	6500 lm	4000 K	white	Base plate, full mould, oblong	with control element	2 1022.2930	1022.2931
57 W	6200 lm	3000 K	white	Base plate, full mould, oblong	with control element	2 1022.2922	1022.2923
57 W	6500 lm	4000 K	silver	Base plate, full mould, oblong	without control element	1 1022.2814	1022.2815
57 W	6200 lm	3000 K	silver	Base plate, full mould, oblong	without control element	1 1022.2806	1022.2807
57 W	6500 lm	4000 K	silver	Base plate, full mould, oblong	with control element	2 1022.2818	1022.2819
57 W	6200 lm	3000 K	silver	Base plate, full mould, oblong	with control element	2 1022.2810	1022.2811
57 W	6500 lm	4000 K	black	Base plate, full mould, oblong	without control element	1 1022.2902	1022.2903
57 W	6200 lm	3000 K	black	Base plate, full mould, oblong	without control element	1 1022.2894	1022.2895
57 W	6500 lm	4000 K	black	Base plate, full mould, oblong	with control element	2 1022.2906	1022.2907
57 W	6200 lm	3000 K	black	Base plate, full mould, oblong	with control element	2 1022.2898	1022.2899
57 W	6500 lm	4000 K	white	Base plate, U-shaped	without control element	3 1022.2928	1022.2929
57 W	6200 lm	3000 K	white	Base plate, U-shaped	without control element	3 1022.2920	1022.2921
57 W	6500 lm	4000 K	white	Base plate, U-shaped	with control element	4 1022.2932	1022.2933
57 W	6200 lm	3000 K	white	Base plate, U-shaped	with control element	4 1022.2924	1022.2925
57 W	6500 lm	4000 K	silver	Base plate, U-shaped	without control element	3 1022.2816	1022.2817
57 W	6200 lm	3000 K	silver	Base plate, U-shaped	without control element	3 1022.2808	1022.2809
57 W	6500 lm	4000 K	silver	Base plate, U-shaped	with control element	4 1022.2820	1022.2821
57 W	6200 lm	3000 K	silver	Base plate, U-shaped	with control element	4 1022.2812	1022.2813
57 W	6500 lm	4000 K	black	Base plate, U-shaped	without control element	3 1022.2904	1022.2905
57 W	6200 lm	3000 K	black	Base plate, U-shaped	without control element	3 1022.2896	1022.2897
57 W	6500 lm	4000 K	black	Base plate, U-shaped	with control element	4 1022.2908	1022.2909
57 W	6200 lm	3000 K	black	Base plate, U-shaped	with control element	4 1022.2900	1022.2901

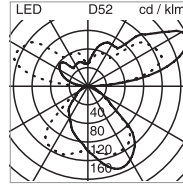
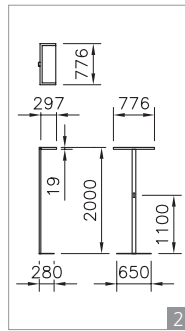
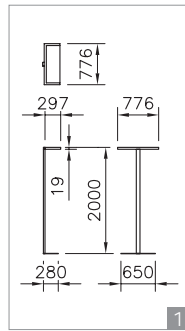

FREESTANDING LUMINAIRE LIGHTPAD LED
FOR SINGLE PERSON WORKSTATION, CENTRAL

System power	Luminous flux of luminaire	Colour temperature	Colour	Base plate shape	Control element	Ref. n° Plug: CH	Ref. n° Plug: EU
58 W	6800 lm	4000 K	white	Base plate, full mould, oblong	without control element	1 1022.2938	1022.2939
58 W	6500 lm	3000 K	white	Base plate, full mould, oblong	without control element	1 1022.2934	1022.2935
58 W	6800 lm	4000 K	white	Base plate, full mould, oblong	with control element	2 1022.2940	1022.2941
58 W	6500 lm	3000 K	white	Base plate, full mould, oblong	with control element	2 1022.2936	1022.2937
58 W	6800 lm	4000 K	silver	Base plate, full mould, oblong	without control element	1 1022.2826	1022.2827
58 W	6500 lm	3000 K	silver	Base plate, full mould, oblong	without control element	1 1022.2822	1022.2823
58 W	6800 lm	4000 K	silver	Base plate, full mould, oblong	with control element	2 1022.2828	1022.2829
58 W	6500 lm	3000 K	silver	Base plate, full mould, oblong	with control element	2 1022.2824	1022.2825

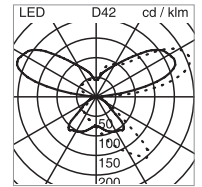
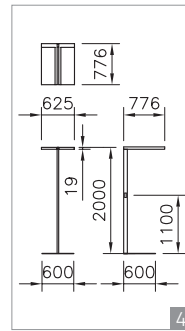
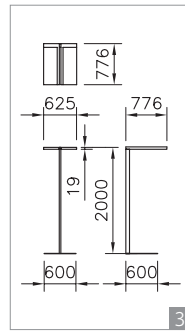
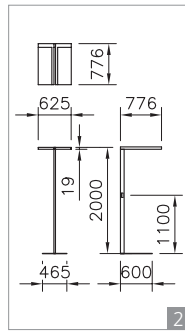
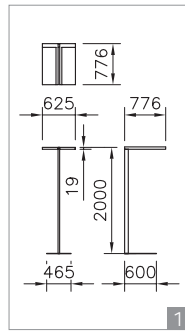

FREESTANDING LUMINAIRE LIGHTPAD LED
FOR TWO PERSON WORKSTATION, LATERAL

System power	Luminous flux of luminaire	Colour temperature	Colour	Base plate shape	Control element	Ref. n° Plug: CH	Ref. n° Plug: EU
98 W	11400 lm	4000 K	white	Base plate, U-shaped	without control element	1 1022.2946	1022.2947
98 W	10900 lm	3000 K	white	Base plate, U-shaped	without control element	1 1022.2942	1022.2943
98 W	11400 lm	4000 K	white	Base plate, U-shaped	with 2 control elements	2 1022.2948	1022.2949
98 W	10900 lm	3000 K	white	Base plate, U-shaped	with 2 control elements	2 1022.2944	1022.2945
98 W	11400 lm	4000 K	silver	Base plate, U-shaped	without control element	1 1022.2834	1022.2835
98 W	10900 lm	3000 K	silver	Base plate, U-shaped	without control element	1 1022.2830	1022.2831
98 W	11400 lm	4000 K	silver	Base plate, U-shaped	with 2 control elements	2 1022.2836	1022.2837
98 W	10900 lm	3000 K	silver	Base plate, U-shaped	with 2 control elements	2 1022.2832	1022.2833
98 W	11400 lm	4000 K	black	Base plate, U-shaped	without control element	1 1022.2914	1022.2915
98 W	10900 lm	3000 K	black	Base plate, U-shaped	without control element	1 1022.2910	1022.2911
98 W	11400 lm	4000 K	black	Base plate, U-shaped	with 2 control elements	2 1022.2916	1022.2917
98 W	10900 lm	3000 K	black	Base plate, U-shaped	with 2 control elements	2 1022.2912	1022.2913
98 W	11400 lm	4000 K	white	Base plate, U-shaped XL	without control element	3 1023.0379	1023.0380
98 W	10900 lm	3000 K	white	Base plate, U-shaped XL	without control element	3 1023.0375	1023.0376
98 W	11400 lm	4000 K	white	Base plate, U-shaped XL	with 2 control elements	4 1023.0381	1023.0382
98 W	10900 lm	3000 K	white	Base plate, U-shaped XL	with 2 control elements	4 1023.0377	1023.0378
98 W	11400 lm	4000 K	silver	Base plate, U-shaped XL	without control element	3 1023.0362	1023.0363
98 W	10900 lm	3000 K	silver	Base plate, U-shaped XL	without control element	3 1023.0358	1023.0359
98 W	11400 lm	4000 K	silver	Base plate, U-shaped XL	with 2 control elements	4 1023.0364	1023.0366
98 W	10900 lm	3000 K	silver	Base plate, U-shaped XL	with 2 control elements	4 1023.0360	1023.0361
98 W	11400 lm	4000 K	black	Base plate, U-shaped XL	without control element	3 1023.0371	1023.0372
98 W	10900 lm	3000 K	black	Base plate, U-shaped XL	without control element	3 1023.0367	1023.0368
98 W	11400 lm	4000 K	black	Base plate, U-shaped XL	with 2 control elements	4 1023.0373	1023.0374
98 W	10900 lm	3000 K	black	Base plate, U-shaped XL	with 2 control elements	4 1023.0369	1023.0370

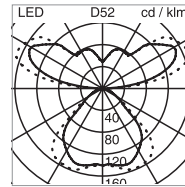
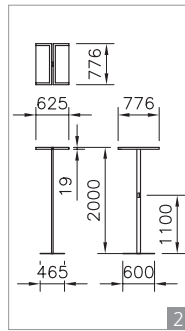
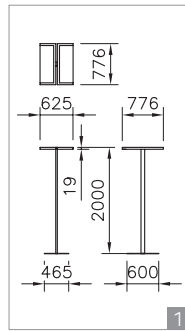

FREESTANDING LUMINAIRE LIGHTPAD LED
FOR TWO PERSON WORKSTATION, CENTRAL

System power	Luminous flux of luminaire	Colour temperature	Colour	Base plate shape	Control element	Ref. n° Plug: CH	Ref. n° Plug: EU
96 W	11400 lm	4000 K	white	Base plate, full mould	without control element	1 1022.2958	1022.2959
96 W	10900 lm	3000 K	white	Base plate, full mould	without control element	1 1022.2950	1022.2951
96 W	11400 lm	4000 K	white	Base plate, full mould	with 2 control elements	2 1022.2962	1022.2963
96 W	10900 lm	3000 K	white	Base plate, full mould	with 2 control elements	2 1022.2954	1022.2955
96 W	11400 lm	4000 K	silver	Base plate, full mould	without control element	1 1022.2846	1022.2847
96 W	10900 lm	3000 K	silver	Base plate, full mould	without control element	1 1022.2838	1022.2839
96 W	11400 lm	4000 K	silver	Base plate, full mould	with 2 control elements	2 1022.2850	1022.2851
96 W	10900 lm	3000 K	silver	Base plate, full mould	with 2 control elements	2 1022.2842	1022.2843
96 W	11400 lm	4000 K	white	Base plate, H-shaped	without control element	1 1023.0486	1023.0487
96 W	10900 lm	3000 K	white	Base plate, H-shaped	without control element	1 1023.0482	1023.0483
96 W	11400 lm	4000 K	white	Base plate, H-shaped	with 2 control elements	2 1023.0488	1023.0489
96 W	10900 lm	3000 K	white	Base plate, H-shaped	with 2 control elements	2 1023.0484	1023.0485
96 W	11400 lm	4000 K	silver	Base plate, H-shaped	without control element	1 1023.0478	1023.0479
96 W	10900 lm	3000 K	silver	Base plate, H-shaped	without control element	1 1023.0474	1023.0475
96 W	11400 lm	4000 K	silver	Base plate, H-shaped	with 2 control elements	2 1023.0480	1023.0481
96 W	10900 lm	3000 K	silver	Base plate, H-shaped	with 2 control elements	2 1023.0476	1023.0477

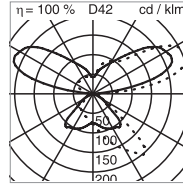
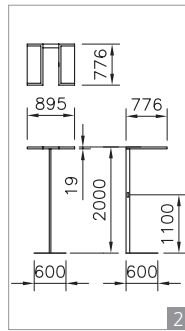
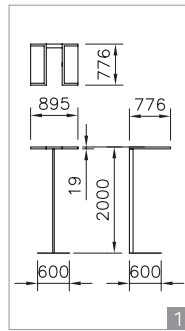

FREESTANDING LUMINAIRE LIGHTPAD LED

FOR TWO PERSON WORKSTATION, LATERAL, WELL SPACED

System power	Luminous flux of luminaire	Colour temperature	Colour	Base plate shape	Control element	Ref. n° Plug: CH	Ref. n° Plug: EU
98 W	11400 lm	4000 K	white	Base plate, U-shaped XL	without control element	1 1023.0322	1023.0323
98 W	10900 lm	3000 K	white	Base plate, U-shaped XL	without control element	1 1023.0318	1023.0319
98 W	11400 lm	4000 K	white	Base plate, U-shaped XL	with 2 control elements	2 1023.0324	1023.0325
98 W	10900 lm	3000 K	white	Base plate, U-shaped XL	with 2 control elements	2 1023.0320	1023.0321
98 W	11400 lm	4000 K	silver	Base plate, U-shaped XL	without control element	1 1023.0314	1023.0315
98 W	10900 lm	3000 K	silver	Base plate, U-shaped XL	without control element	1 1023.0310	1023.0311
98 W	11400 lm	4000 K	silver	Base plate, U-shaped XL	with 2 control elements	2 1023.0316	1023.0317
98 W	10900 lm	3000 K	silver	Base plate, U-shaped XL	with 2 control elements	2 1023.0312	1023.0313

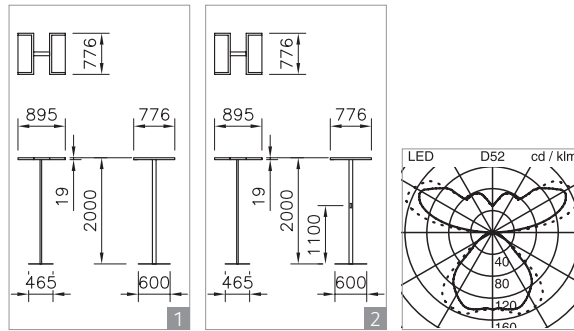

FREESTANDING LUMINAIRE LIGHTPAD LED

FOR TWO PERSON WORKSTATION, CENTRAL, WELL-SPACED

System power	Luminous flux of luminaire	Colour temperature	Colour	Base plate shape	Control element	Ref. n° Plug: CH	Ref. n° Plug: EU
96 W	11400 lm	4000 K	white	Base plate, full mould	without control element	1 1022.2998	1022.2999
96 W	10900 lm	3000 K	white	Base plate, full mould	without control element	1 1022.2990	1022.2991
96 W	11400 lm	4000 K	white	Base plate, full mould	with 2 control elements	2 1022.3002	1022.3003
96 W	10900 lm	3000 K	white	Base plate, full mould	with 2 control elements	2 1022.2994	1022.2995
96 W	11400 lm	4000 K	silver	Base plate, full mould	without control element	1 1022.2886	1022.2887
96 W	10900 lm	3000 K	silver	Base plate, full mould	without control element	1 1022.2878	1022.2879
96 W	11400 lm	4000 K	silver	Base plate, full mould	with 2 control elements	2 1022.2890	1022.2891
96 W	10900 lm	3000 K	silver	Base plate, full mould	with 2 control elements	2 1022.2882	1022.2883
96 W	11400 lm	4000 K	white	Base plate, H-shaped	without control element	1 1023.0503	1023.0504
96 W	10900 lm	3000 K	white	Base plate, H-shaped	without control element	1 1023.0498	1023.0499
96 W	11400 lm	4000 K	white	Base plate, H-shaped	with 2 control elements	2 1023.0505	1023.0506
96 W	10900 lm	3000 K	white	Base plate, H-shaped	with 2 control elements	2 1023.0500	1023.0501
96 W	11400 lm	4000 K	silver	Base plate, H-shaped	without control element	1 1023.0494	1023.0495
96 W	10900 lm	3000 K	silver	Base plate, H-shaped	without control element	1 1023.0490	1023.0491
96 W	11400 lm	4000 K	silver	Base plate, H-shaped	with 2 control elements	2 1023.0496	1023.0497
96 W	10900 lm	3000 K	silver	Base plate, H-shaped	with 2 control elements	2 1023.0492	1023.0493

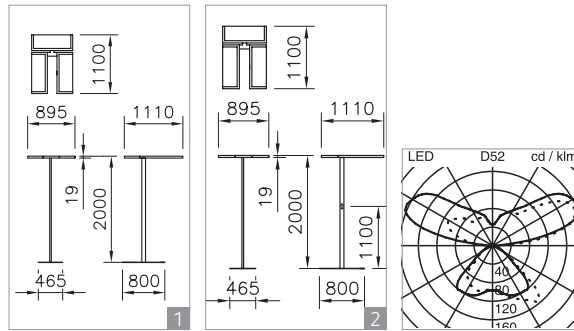

FREESTANDING LUMINAIRE LIGHTPAD LED
FOR THREE PERSON WORKSTATION

System power	Luminous flux of luminaire	Colour temperature	Colour	Base plate shape	Control element	Ref. n° Plug: CH	Ref. n° Plug: EU
147 W	17100 lm	4000 K	white	Base plate, H-shaped	without control element	1 1023.0338	1023.0339
147 W	16300 lm	3000 K	white	Base plate, H-shaped	without control element	1 1023.0334	1023.0335
147 W	17100 lm	4000 K	white	Base plate, H-shaped	with 3 control elements	2 1023.0340	1023.0341
147 W	16300 lm	3000 K	white	Base plate, H-shaped	with 3 control elements	2 1023.0336	1023.0337
147 W	17100 lm	4000 K	silver	Base plate, H-shaped	without control element	1 1023.0330	1023.0331
147 W	16300 lm	3000 K	silver	Base plate, H-shaped	without control element	1 1023.0326	1023.0327
147 W	17100 lm	4000 K	silver	Base plate, H-shaped	with 3 control elements	2 1023.0332	1023.0333
147 W	16300 lm	3000 K	silver	Base plate, H-shaped	with 3 control elements	2 1023.0328	1023.0329

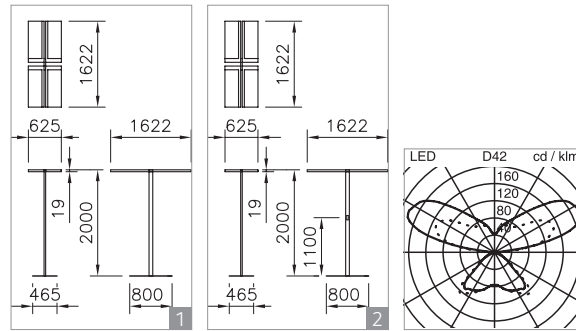

FREESTANDING LUMINAIRE LIGHTPAD LED
FOR FOUR PERSON WORKSTATION

System power	Luminous flux of luminaire	Colour temperature	Colour	Base plate shape	Control element	Ref. n° Plug: CH	Ref. n° Plug: EU
196 W	22800 lm	4000 K	white	Base plate, H-shaped	without control element	1 1023.0354	1023.0355
196 W	21700 lm	3000 K	white	Base plate, H-shaped	without control element	1 1023.0350	1023.0351
196 W	22800 lm	4000 K	white	Base plate, H-shaped	with 4 control elements	2 1023.0356	1023.0357
196 W	21700 lm	3000 K	white	Base plate, H-shaped	with 4 control elements	2 1023.0352	1023.0353
196 W	22800 lm	4000 K	silver	Base plate, H-shaped	without control element	1 1023.0346	1023.0347
196 W	21700 lm	3000 K	silver	Base plate, H-shaped	without control element	1 1023.0342	1023.0343
196 W	22800 lm	4000 K	silver	Base plate, H-shaped	with 4 control elements	2 1023.0348	1023.0349
196 W	21700 lm	3000 K	silver	Base plate, H-shaped	with 4 control elements	2 1023.0344	1023.0345



COMMUNICATION MODULE ALONE AT WORK

Notes	Ref. n°
	1022.6646

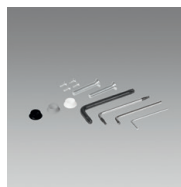

MOUNTING SET LIGHTPAD LED

Notes	Ref. n°
	1022.6764